

# Sensors for Automation

## Catalog Section Capacitive Sensors

ALSEN TK 9  
Edition 4.11 \_20



**Klaschka**  
**Industrieelektronik GmbH**  
Am Zeller Pfad 1  
75242 Neuhausen / Enzkreis  
Germany  
Fon +49 7234 79-0  
Fax +49 7234 79-112  
[vertrieb@klaschka.de](mailto:vertrieb@klaschka.de)  
[www.klaschka.de](http://www.klaschka.de)

# Capacitive Sensors

## Contents

---

### **0 Introduction**

0.0.2 Articles sorted by ref. no. and type

### **9 Capacitive Sensors**

9.0.1 Task, mode of operation and application examples

9.0.2 Mounting instructions

#### **9.1 Capacitive DC 3-pole**

9.1.0.1 Characteristics, overview

9.1.1.1 Series KAD-8mg, -12mg, -12fg

9.1.2.1 Series KAD-18mg, -18fg, -30mg, -30fg

**You will find a further selection of sensors from our extensive product range in the following catalogs:**

Catalog Section Inductive Proximity Switches and Accessories **TK 1 + 12.1**

Catalog Section Pulse Sensors and Accessories **TK 2 + 12.1**

Catalog Section Safety Elements and Accessories **TK 5 + 12.2**

Catalog Section Ultrasonic Sensors **TK 8**

<b>Ref. no.</b>	<b>Type designation</b>	<b>Page</b>	<b>Type designation</b>	<b>Ref. no.</b>	<b>Page</b>
13.24-10-020	KAD-12fg80n4-1ND1A	9.1.1.2	KAD-8mg45b1,5-1PDc1A	13.24-17-020	9.1.1.1
13.24-11	KAD-30mg90b20-12Sd1A	9.1.2.2	KAD-12fg80n4-1ND1A	13.24-10-020	9.1.1.2
13.24-12	KAD-30fg60n15-1NKc1A	9.1.2.2	KAD-12mg80b4-1Sc1A	13.24-15	9.1.1.1
13.24-13	KAD-18mg95b8-1Sc1A	9.1.2.1	KAD-18fg60n8-1NKc1A	13.24-14-020	9.1.2.1
13.24-14-020	KAD-18fg60n8-1NKc1A	9.1.2.1	KAD-18mg95b8-1Sc1A	13.24-13	9.1.2.1
13.25-15	KAD-12mg80b4-1Sc1A	9.1.1.1	KAD-30fg60n15-1NKc1A	13.24-12	9.1.2.2
13.24-17-020	KAD-8mg45b1,5-1PDc1A	9.1.1.1	KAD-30mg90b20-12Sd1A	13.24-11	9.1.2.2

# Capacitive Proximity Switches

## Task, mode of operation and application examples

### Task

Capacitive proximity switches can detect both metallic and non-metallic objects, in particular solid, powder, and liquid materials. This makes them especially suitable as sensors for level and filling control.

### Mode of operation

In principle, capacitive proximity switches exhibit a similar configuration as inductive proximity switches. They consist of an oscillator O with an active sensor element E, a rectifier R and a switching amplifier with output stage A. The sensor element E is designed as an array of electrodes acting as an open capacitor.

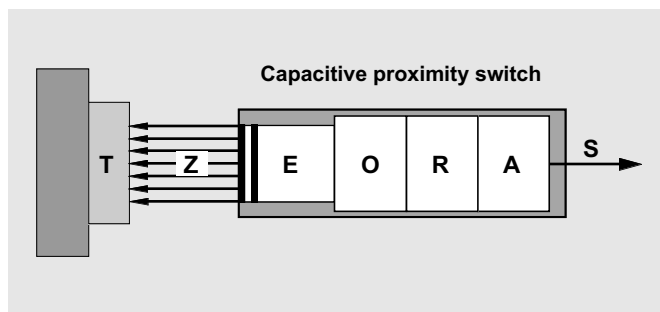

When a metallic or dielectric target T enters the active zone Z in front of the sensor element E, the capacitance of E changes and thus affects the oscillator O. Rectifier R and amplifier A convert the modified oscillator signal into an output signal S.

### Application examples

- Level monitoring of granular or bulk materials in silos and other containers
- Monitoring the filling levels of liquids
- Monitoring the height of paper stacks
- Breakage monitoring of drive belts and conveyors
- Material flow monitoring in mixing systems
- Edging monitoring of plastic film
- Counting sensors in the packaging, foodstuffs, wood and plastics industries
- Selection of liquids with differing dielectric properties

### Recommendations

Compared to inductive proximity switches, the operating distance of capacitive proximity switches depends to a large extent on material and mass of the target and the mounting and surroundings. For this reason, capacitive proximity switches have a built-in potentiometer. It is accessible by means of a screw driver and allows to tune the switching distance. Standard DIN EN 60947-5-2 defines the rated operating distance  $s_n$  as maximal distance between a standard measuring plate and the sensing face of the sensor generating an output signal.

The measuring plate is a 1 mm thick square steel plate (ST37). The edge length is equal either to the diameter or the resp. lateral length of the sensing face or to three times  $s_n$ . The greater value is valid. The measuring plate must be grounded.

The stated value for  $s_n$  is the absolute upper limiting operating distance of the corresponding capacitive proximity switch. Other target materials, especially non-metals, lead to smaller operating distances, strongly depending on the material-specific dielectric constant  $\epsilon_r$ .

### Sensitivity setting

A potentiometer allows to set the sensitivity for different materials and local conditions. The realizable operating distance depends on the material of the measurement target.

### Material correction factor

The table below shows correction factors for several materials. They determine the material-specific maximum operating distance in relation to the rated operating distance  $s_n$ . For the different sensor models, the values for  $s_n$  are indicated in the tables on page 9.1.0.1

Material	Correction factor
Metals (grounded)	1,0
Metals (not grounded)	0,8
Water (grounded)	1,0
Glass	0,5
Plastics (PVC, polyamide)	0,6
Cardboard	0,3
Wood (depends on degree of humidity)	0,2 ... 0,7
Oil (depends on composition)	0 ... 0,3

With **strongly wetting liquids**, traces adhering to container walls or directly to the sensor housing may evoke malfunctions

The degree of humidity within **organic materials**, such as wood or cardboard targets, has a strong influence. A higher degree of humidity increases the operating distance.

In general, **oils** are good insulators and mostly difficult to detect by the use of capacitive proximity switches. If necessary, the practicable operating distance must be determined empirically.

Non-flush mountable capacitive proximity switches may be flush mounted in plastics with a low dielectric constant.

# Mounting instructions

## Mounting instructions for cylindrical sensors

**Flush mounting (b):** A cylindrical capacitive sensor is flush mountable if an arbitrary damping material can be attached around the sensing face, without affecting the characteristics.

The flush mountable sensor with the diameter  $d$  and the rated operating distance  $s_n$  can be mounted with the sensing face AF flush in metal. The following mounting instructions apply:

- Distance between the centre of two sensors when these are arranged in row  $\geq 2d$
- Distance to an opposite metal face  $\geq 3s_n$
- Distance to a side face  $\geq d$

**Non-flush mounting (n):** A capacitive sensor is non-flush mountable if a certain free zone around its sensing face is required in order to maintain its characteristics.

The non-flush mountable sensor with the diameter  $d$  and the rated operating distance  $s_n$  has to stick out of the metal surface by at least  $2s_n$ . The following mounting instructions apply:

- Distance between the centre of two sensors when these are arranged in a row  $\geq 3d$
- Distance of the sensing face to an opposite metal face  $\geq 3s_n$
- Distance to a side face  $\geq d$

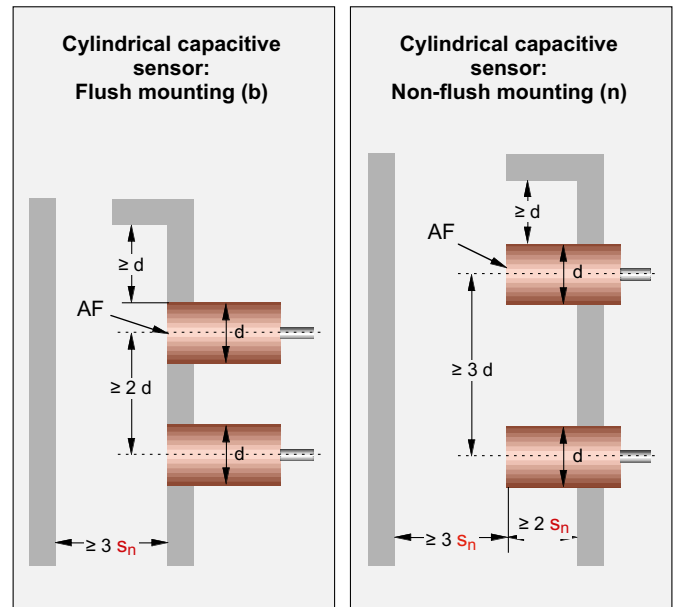

## Mounting instructions for rectangular sensors

**Flush mounting (b):** A rectangular capacitive sensor allows flush mounting if it can be mounted up to the sensing face on an arbitrary damping material without affecting the characteristics.

The flush mountable sensor with the width  $b$  and the rated operating distance  $s_n$  can be mounted with the sensing face AF flush in metal. The following mounting instructions apply:

- Distance between the centre of two sensors when these are arranged in a row  $\geq 2b$
- Distance to an opposite metal face  $\geq 3s_n$
- Distance to a side face  $\geq b$

In case of L- or U-shaped mounting into a metallic environment (see diagram below) the value  $e \geq s$  is to be kept.

**Non-flush mounting (n):** A rectangular capacitive sensor is non-flush mountable if a certain free zone around its sensing face is necessary in order to maintain its characteristics.

The non-flush mountable sensor with the width  $b$  and the rated operating distance  $s_n$  has to stick out of the metal at least by  $b$ . The following mounting instructions apply:

- Distance between the centre of two sensors when these are arranged in a row  $\geq 3b$
- Distance of the sensing face to an opposite metal face  $\geq 3s_n$
- Distance to a side face  $\geq b$

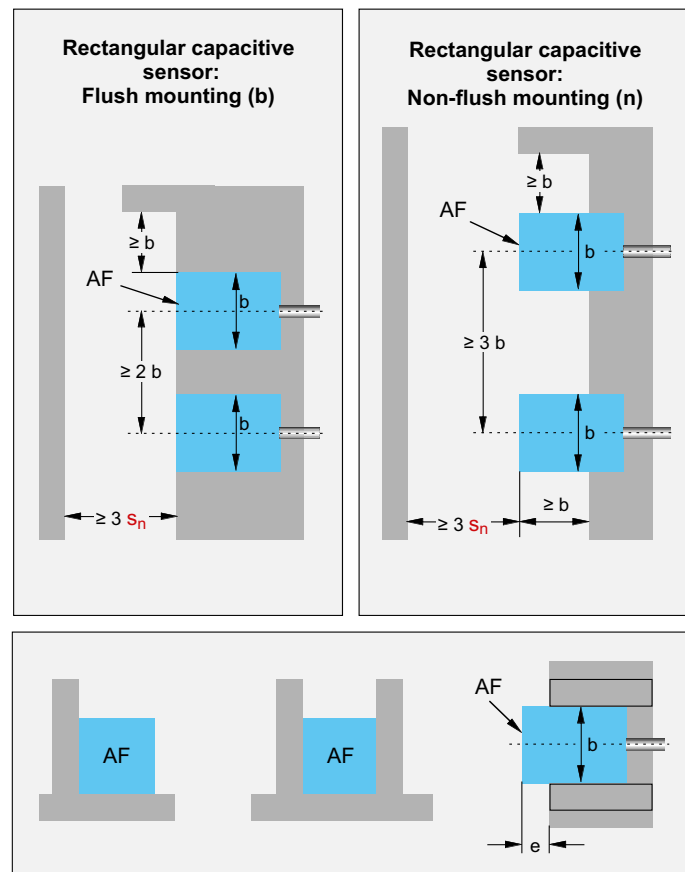

## Notes

---

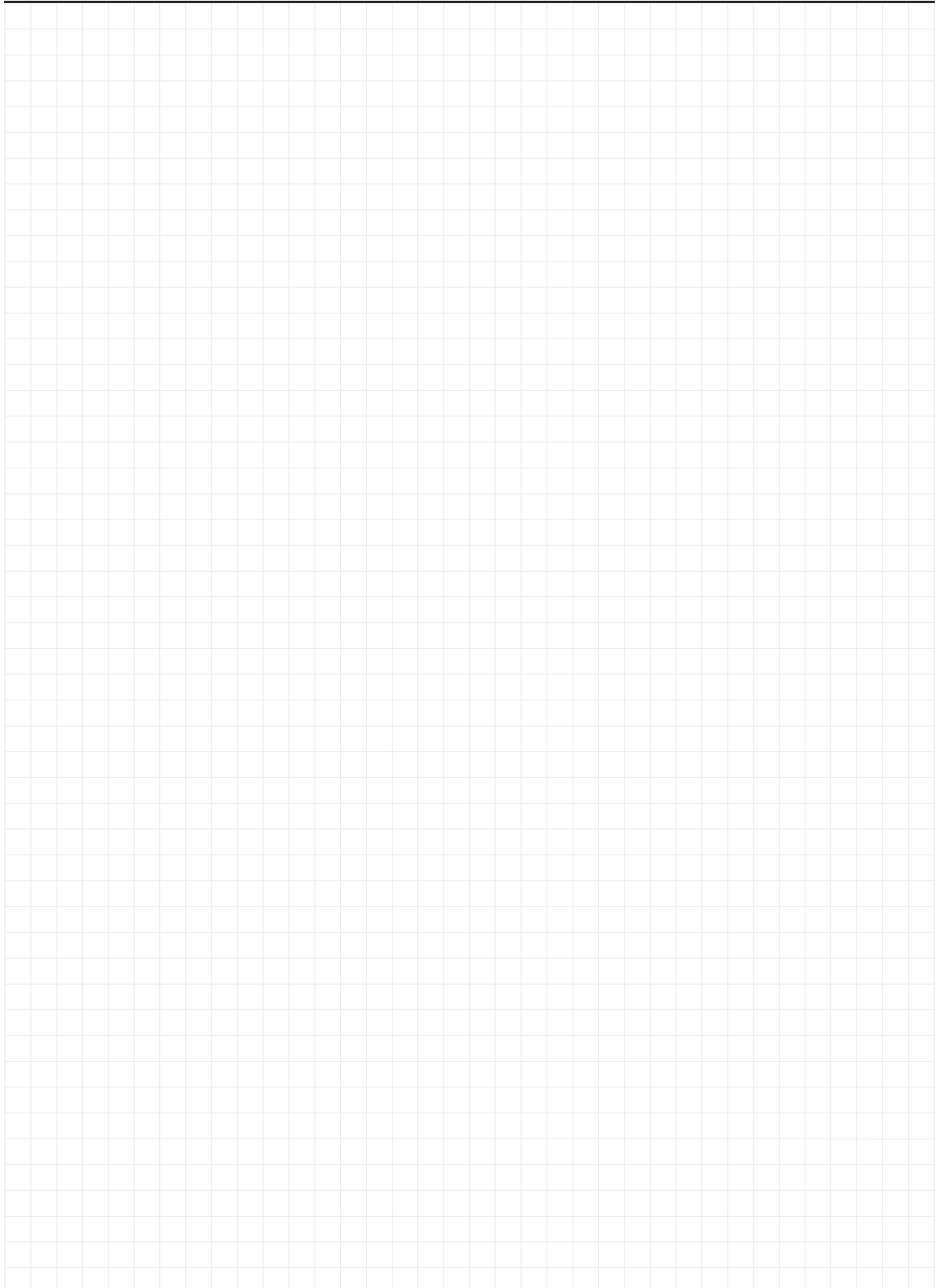

**Characteristics**



Type	Ref. no.	Switching distance in mm mounting *)
KAD-8mg45b1,5-1PDc1A	13.24-17-020	1.5 b
KAD-12mg80b4-1Sc1A	13.24-15	4.0 b
KAD-12fg80n4-1ND1A	13.24-10-020	4.0 n

Type	Ref. no.	Switching distance in mm mounting *)
KAD-18mg95b8-1Sc1A	13.24-13	8.0 b
KAD-18fg60n8-1NKc1A	13.24-14-020	8.0 n
KAD-30mg90b20-12Sd1A	13.24-11	20.0 b
KAD-30fg60n15-1NKc1A	13.24-12-020	15.0 n

\*) b = flush mounting, n = non-flush mounting

# Capacitive Proximity Switches

## Series KAD-8mg, -12mg, -12fg

Design; length		O M8 x 1; 45 mm	O M12 x 1; 80 mm
Material of the sensing face / of the housing		POM / brass	POM / brass
Rated operating distance, mounting (see page 9.0.2)		1.5 mm, flush	4 mm, flush
Range assured operating distance		0 ... 1.22 mm	0 ... 3.24 mm
Type designation, Ref. no. (Wiring)	NO plus-switching NOp	KAD-8mg45b1,5-1PDc1A, 13.24-17-020 (1)	KAD-12mg80b4-1Sc1A, 13.24-15 (2)
	NC plus-switching NCp		
	NO and NC plus-switching NOp + NCp		
	NO plus-, NC minus-switching NOp + NCn		
	NO minus-switching NOn		
	NC minus-switching NCn		
Maximum switching frequency / Minimum damping period		100 Hz / 5 ms	100 Hz / 5 ms
Wiring (connector or lead); number of wires		lead; 3 wires	connector M12; 3 wires
<b>Common Technical Data</b>			
Hysteresis of the switching point s		≤ 15 %	
Repetition accuracy of the switching point s		≤ 5 %	
Permissible ripple voltage		≤ 10 %	
Short-circuit-proof ?		yes, clocking	
Reverse polarity protection ?		yes	
Voltage drop across a closed output		≤ 2 V DC	
Ambient temperature range		- 25 ... + 70 °C	
For 13.24-10, the following applies:			
Repetition accuracy of the switching point s		≤ 10 %	
- with consistent operating voltage			
... and ambient temperature		≤ 5 %	
Voltage drop across a closed output		≤ 3 V DC	
<b>Specific Technical Data</b>			
Permissible operating voltage range		10 ... 24 ... 30 V DC	10 ... 24 ... 30 V DC
Current consumption without load		≤ 10 mA	≤ 10 mA
Load current		≤ 200 mA	≤ 200 mA
Ø Sensing face		6.4 mm	10.5 mm
Function display ?		yes, YE	yes, YE
Maximum length of the lead		300 m	300 m
Lead type / standard lead length / number of wires x lead cross section		PUR / 2.0 m / 3 x 0.15 mm <sup>2</sup>	
EMC class		IEC 60947-5-2	IEC 60947-5-2
Protection rating according to IEC 60529		IP 67	IP 67
Protection class			
Permissible starting torque without / with toothed disc		6 Nm / 12 Nm	9 Nm / 30 Nm
Weight		10 g + weight of the lead	40 g
Recommended accessories		chapter 12.1	chapter 12.1

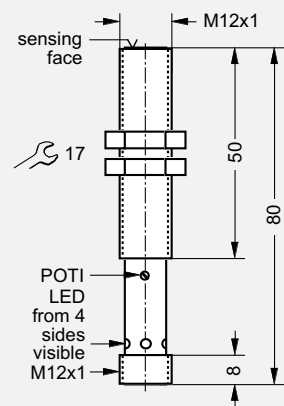
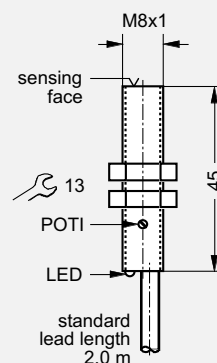

For proximity switches with connectors: Please find the required connector with connecting lead in chapter 12 "Accessories". Order separately.

For proximity switches with connecting lead: The standard length is 2.0 m or 5.0 m. Lead lengths are marked at the end of the ref. no. by index -020 or -050. In case that deviating lengths are required, please indicate this in the ref. no.

Examples: Lead length 10.0 m: Index -100, lead length 0.5 m: Index -005.

### Certifications

Proximity switches according to standard:  
DIN EN 60 947-5-2 (VDE 0660 Part 208).

We are certified according to DIN EN ISO 9001.



### Safety Regulations

Connection, commissioning and maintenance may only be accomplished by specialists or instructed staff.

Subject to technical changes!

### Wiring (1)

DC 3 poles, connecting lead

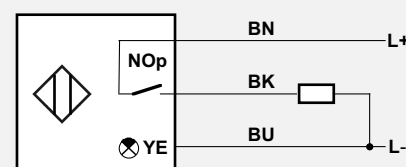

### Wiring (2)

DC 3 poles, plug

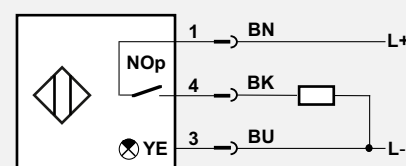

Euro Plug M12  
with LED display YE

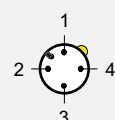



<b>O M12 x 1; 80 mm</b>			
PA 6.6 / PA 6.6			
<b>4 mm, non-flush</b>			
0 ... 3.24 mm			
KAD-12fg80n4-1ND1A, 13.24-10-020 (1)			
<b>15 Hz / 67 ms</b>			
lead; 3 wires			

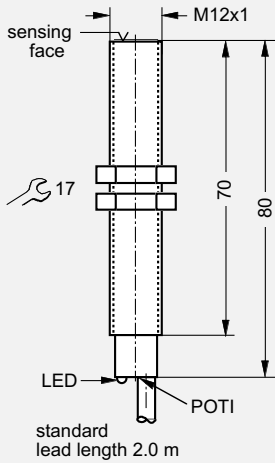

10 ... 24 ... 30 V DC			
≤ 20 mA			
≤ 200 mA			
10.5 mm			
yes, YE			
500 m			
PVC / 2.0 m / 3 x 0.34 mm <sup>2</sup>			
IEC 60947-5-2, Part 7.4.1 + 7.4.2			
IP 67			
II,			
1.5 Nm / 2 Nm			
35 g + weight of the lead			
chapter 12.1			

# Capacitive Proximity Switches

## Series KAD-18mg, -18fg, -30mg, -30fg

Design; length		O M18 x 1; 95 mm	O M18 x 1; 60 mm
Material of the sensing face / of the housing		PBT / brass	PA 6.6 / PA 6.6
Rated operating distance, mounting (see page 9.0.2)		8 mm, flush	8 mm, non-flush
Range assured operating distance		0 ... 6.48 mm	0 ... 6.48 mm
Type designation, Ref. no. (Wiring)	NO plus-switching NOp	KAD-18mg95b8-1Sc1A, 13.24-13 (1)	KAD-18fg60n8-1NKc1A, 13.24-14-020 (2)
	NC plus-switching NCp		
	NO and NC plus-switching NOp + NCp		
	NO plus-, NC minus-switching NOp + NCn		
	NO minus-switching NOn		
	NC minus-switching NCn		
Maximum switching frequency / Minimum damping period		100 Hz / 5 ms	10 Hz / 50 ms
Wiring (connector or lead); number of wires		connector M12; 3 wires	lead; 3 wires
<b>Common Technical Data</b>			
Hysteresis of the switching point s		≤ 15 %	
Repetition accuracy of the switching point s		≤ 5 %	
Permissible ripple voltage		≤ 10 %	
Short-circuit-proof ?		yes, clocking	
Reverse polarity protection ?		yes	
Voltage drop across a closed output		≤ 2 V DC	
Ambient temperature range		- 25 ... + 70 °C	
For 13.24-12 and 13.24-14, the following applies :			
Voltage drop across a closed output		≤ 3 V DC	
<b>Specific Technical Data</b>			
Permissible operating voltage range		10 ... 24 ... 30 V DC	10 ... 24 ... 30 V DC
Current consumption without load		≤ 10 mA	≤ 20 mA
Load current		≤ 200 mA	≤ 200 mA
Ø Sensing face		16.5 mm	16.5 mm
Function display ?		yes, YE	yes, YE
Maximum lead length		300 m	300 m
Lead type / standard lead length / number of wires x lead cross section			PVC / 2.0 m / 3 x 0.34 mm <sup>2</sup>
EMC class		IEC 60947-5-2	IEC 60947-5-2
Protection rating IEC 60529		IP 67	IP 67
Protection class			
Permissible starting torque without / with toothed disc		34 Nm / 70 Nm	2.5 Nm / 3.5 Nm
Weight		100 g	60 g + weight of the lead
Recommended accessories		chapter 12.1	chapter 12.1

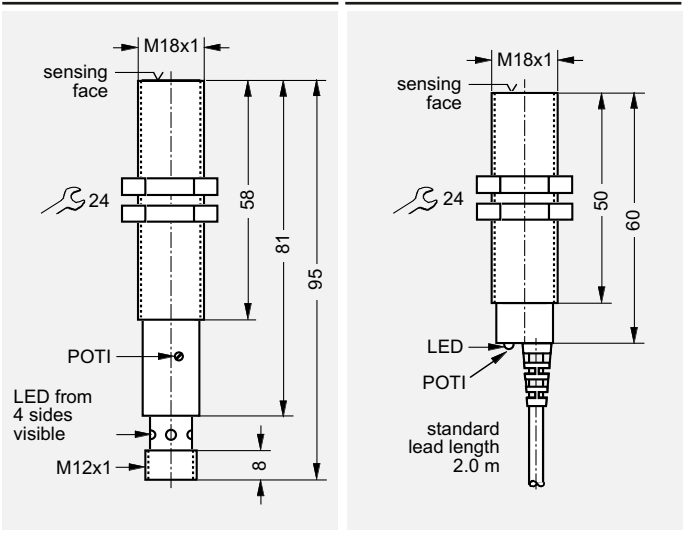

For proximity switches with connectors: Please find the required connector with connecting lead in chapter 12 "Accessories". Order separately.

For proximity switches with connecting lead: The standard length is 2.0 m or 5.0 m. Lead lengths are marked at the end of the ref. no. by index -020 or -050. In case that deviating lengths are required, please indicate this in the ref. no.

Examples: Lead length 10.0 m: Index -100, lead length 0.5 m: Index -005.

### Certifications

Proximity switches according to standard:  
DIN EN 60 947-5-2 (VDE 0660 Part 208).

We are certified according to DIN EN ISO 9001.



### Safety Regulations

Connection, commissioning and maintenance may only be accomplished by specialists or instructed staff.

Subject to technical changes!

### Wiring (1)

DC 3 poles, plug

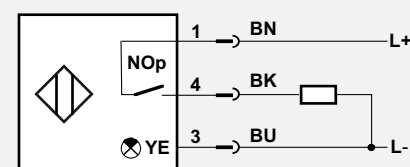

### Euro Plug M12 with LED display YE

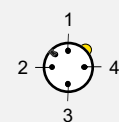

### Wiring (2)

DC 3 poles, connecting lead

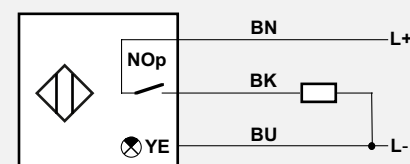

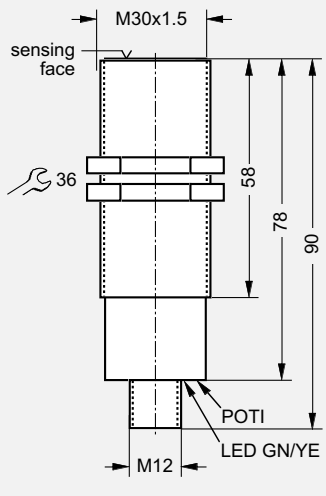
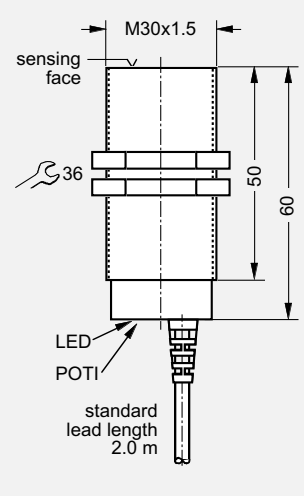
<b>O M30 x 1,5; 90 mm</b>	<b>O M30 x 1,5; 60 mm</b>		
PCP / brass	PA 6.6 / PA 6.6		
<b>20 mm, flush</b>	<b>15 mm, non-flush</b>		
0 ... 16.2 mm	0 ... 12.2 mm		
	KAD-30fg60n15-1NKc1A, 13.24-12-020 (1)		
KAD-30mg90b20-12Sd1A, 13.24-11 (3)			
<b>100 Hz / 5 ms</b>	<b>10 Hz / 50 ms</b>		
connector M12; 4 wires	lead; 4 wires		
			
10 ... 24 ... 30 V DC	10 ... 24 ... 30 V DC		
≤ 10 mA	≤ 20 mA		
≤ 200 mA	≤ 200 mA		
27.4 mm	27.4 mm		
yes, GN/YE	yes, YE		
300 m	300 m		
	PVC / 2.0 m / 3 x 0.34 mm <sup>2</sup>		
IEC 60947-5-2, Part 7.2.6:2004	IEC 60947-5-2		
IP 67	IP 67		
150 Nm / 200 Nm	150 Nm / 200 Nm		
180 g	100 g + weight of the lead		
chapter 12.1	chapter 12.1		

**Wiring (3)**

DC 3 poles, plug

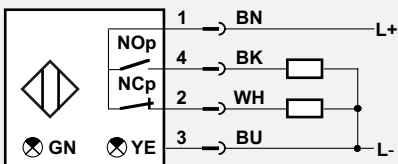

**Euro Plug M12**

with LED display  
GN/YE

